



Achieve even more with

BD MAX™ PLUS

Molecular Diagnostic System



Introducing the

BD MAX™ PLUS

Molecular Diagnostic System

Like you, we have a passion for *advancing the world of health™* and we believe in healthcare innovation that leads to better patient management.

You have trusted BD to provide rapid, easy-to-use diagnostic solutions that deliver the accurate results clinicians need to improve patient care.

You are continuously looking for ways to further optimise workflow efficiency, turnaround time and quality of results.

We heard you.

We have built for you an improved BD MAX™ System to take your lab's efficiency to the next level: the **BD MAX™ PLUS System**.

With hardware and software innovations, the **BD MAX™ PLUS System** is designed to be easy-to-use, provide even more consistent results and enhance laboratory efficiency.¹

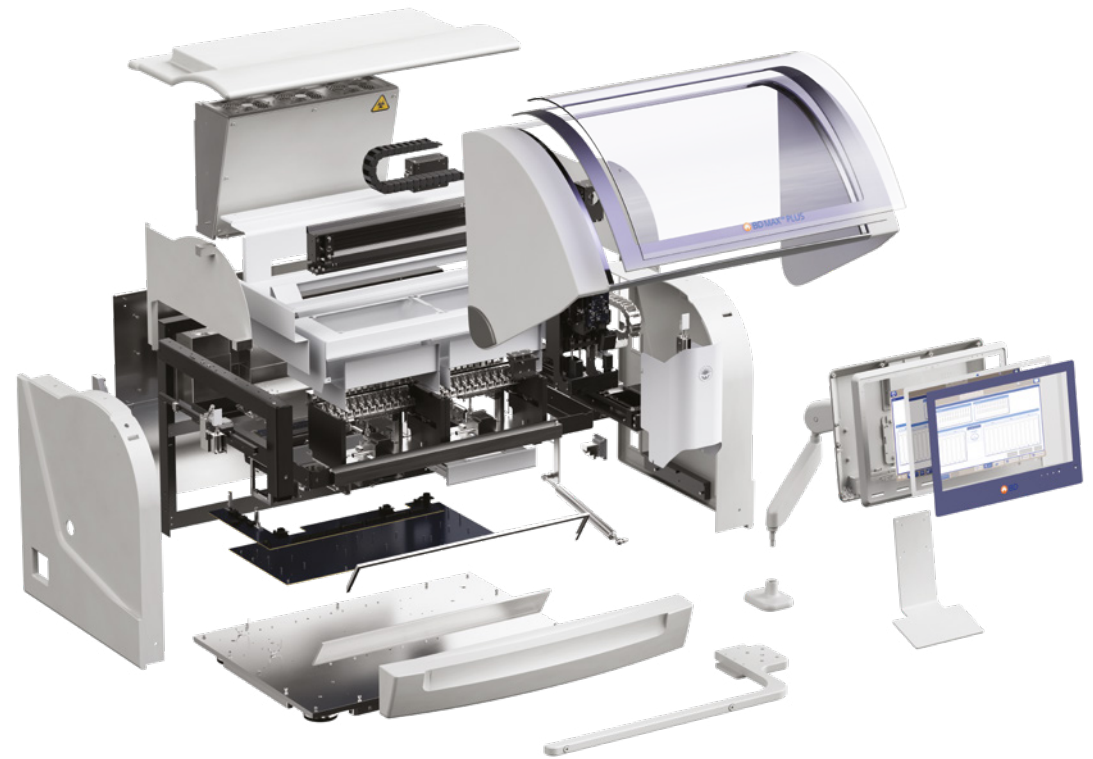

Performance



Efficiency



Versatility

Performance

Enhance the quality of test results and streamline your lab's workflow with our latest hardware and product updates.¹



PCR Tray

The re-engineered **PCR tray** is designed to improve stability and pipetting precision into the PCR wells, which may reduce bubbles and decrease optical noise in the PCR cartridge. Improved stability allows for more even pressure which is designed to offer better heat transfer and alignment with the pipette tips.*

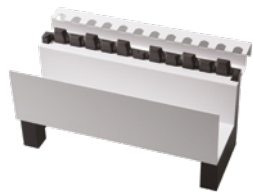

Fixed Magnet Assembly

The BD MAX™ assays use magnetic affinity beads as part of the nucleic acid extraction process. The additional **Fixed Magnet Assembly** minimises magnetic bead carry over during the pipetting process, which is designed to reduce the risk of nonreportable results and the need for sample re-runs for viscous samples.*



Pierceable Cap[†]

The **Pierceable Cap** is a new design for the cap on the Sample Buffer Tube, which eliminates changing the blue septum cap for specimen prep or storage. Because the Pierceable Cap contains a septum that recloses after sample processing, evaporation of the sample is minimised — extending sample storage after testing from 5 hours at room temperature to 4 days for BD MAX™ Vaginal Panel.²

¹Bench Test results may not necessarily be indicative of clinical performance.
[†]Available for all models of the BD MAX™ System.

Efficiency

An innovative design that takes your lab's efficiency to the next level.

Streamlined sample prep and disposal

The compact and self-contained Unitised Reagent Strip is designed to be efficient for your lab:

- All your PCR and extraction chemistries and pipette tips are contained in one Unitised Reagent Strip, making it easy to run anywhere from 1 to 24 samples at a time.
- Reagents are room-temperature stable, making inventory management more flexible and convenient.
- With less than 1.5 minutes hands-on time per specimen, sample preparation is quick.¹³
- After the run, all waste from the extraction process is contained within the strip and can be discarded per your laboratory's standards, simplifying waste management.

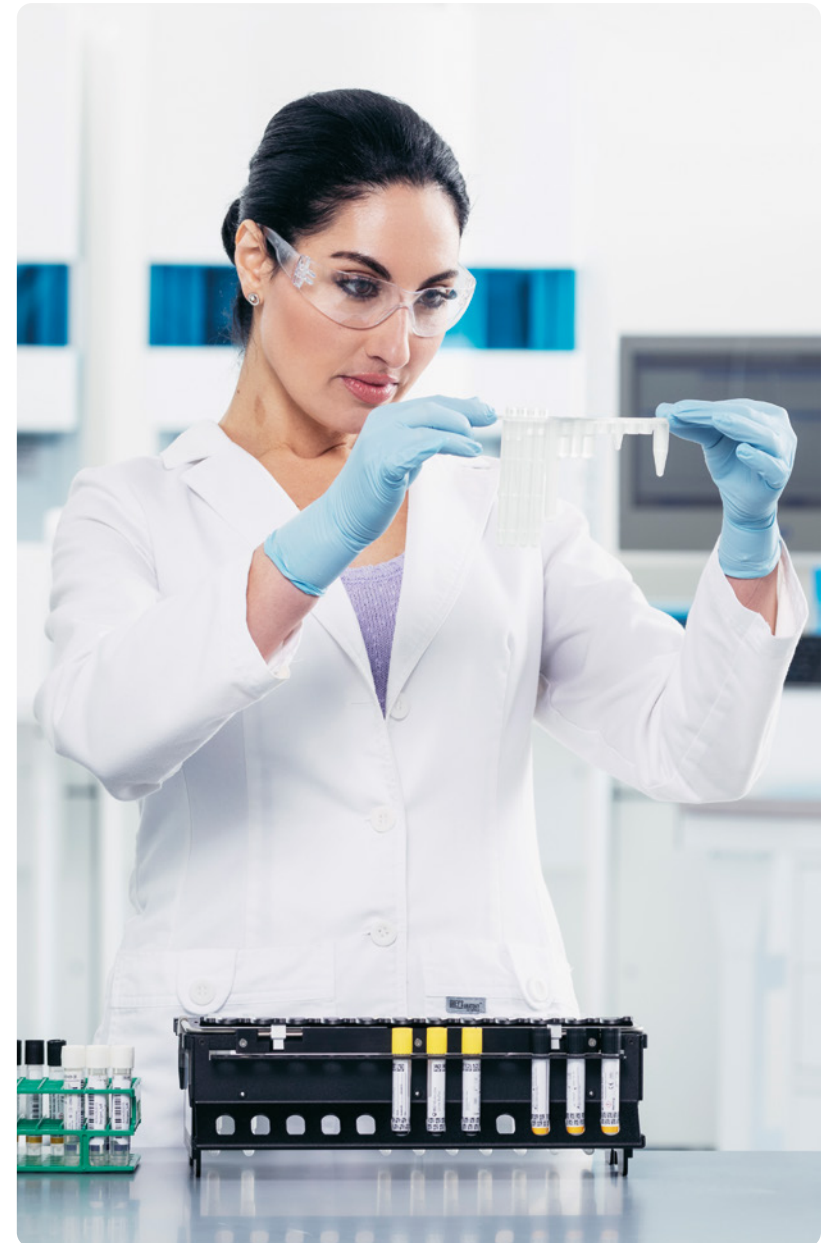

Unitised Reagent Strip:

- 1 Snap-in Tubes
- 2 Waste Reservoir
- 3 Pipette Tips
- 4 Lysis Tube
- 5 Extraction Tube
- 6 Master Mix 1
- 6a Master Mix 2 if required
- 7 Wash Buffer
- 8 Elution Buffer
- 9 Neutralisation Buffer

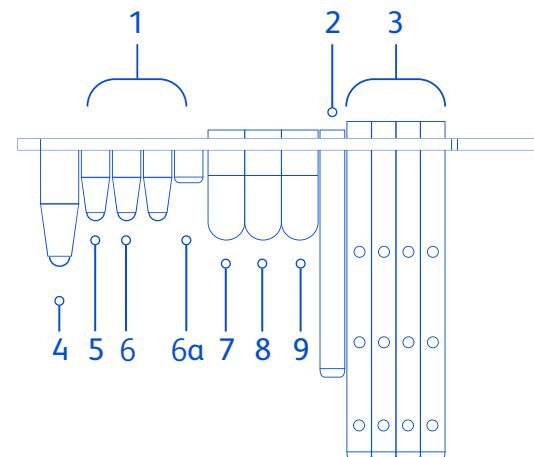

Microfluidic PCR technology designed to standardise your workflow

Our patented PCR cartridge technology utilises microfluidics to have 24 independent PCR reaction chambers:

- > Different assays with unique temperature profiles can be run together, because each of the reaction chambers is heated by an independently-controlled set of heaters.
- > Contamination is minimised as wax valves seal off each chamber that holds the PCR amplification reaction.
- > The size and geometry of the chambers allow for rapid thermal cycling.



Efficiency

A streamlined and flexible workflow to help maximise your lab's throughput.

Streamlined workflow

Flexible batching workflow allows your lab to group multiple assays in a run, providing you walk-away time to perform other tasks in your busy lab.¹

Interleave runs and the **ability to mix-and-match assays** help you to maximise your lab's throughput and efficiency.¹

Ample throughput with fast results

With an average **turnaround time of 2 to 3 hours** for most assays, the BD MAX™ PLUS System runs up to **96 samples in an 8-hour shift**.^{1,4}

Mix-and-match assays

The unique design of the Unitised Reagent Strip, together with the patented PCR Cartridge, allows different assays to be processed together on the same run.



BD MAX™ System automated workflow

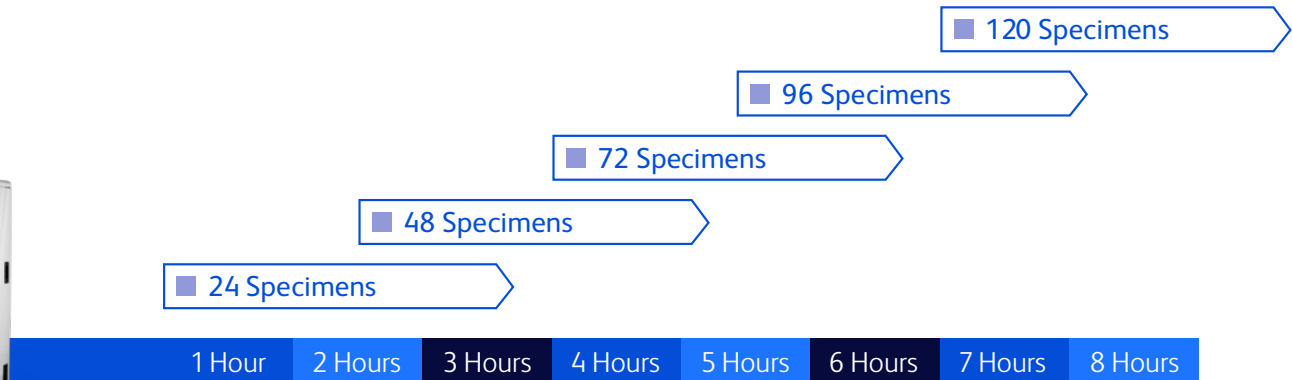
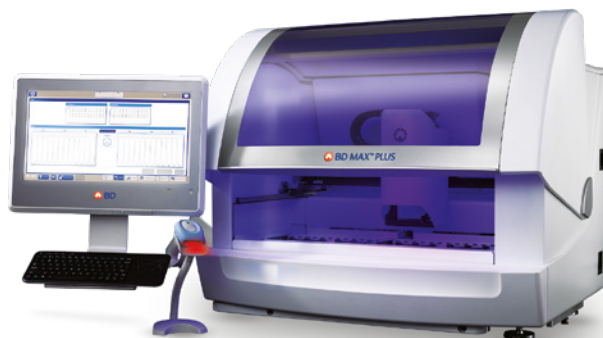

■ Hands-on time¹ □ >2 hours of total walk-away time per run¹



Ergonomic design for more efficiency

The updated All-in-One (AIO) computer offers:

- High-resolution LED panel with a wide-viewing angle
- Four times more memory than the previous generation of AIO computers, which helps to improve processor speed and screen refresh rates
- Antimicrobial glass and housing, along with a front bezel that is IP65-rated for dust and liquid protection
- Solid state hard drive and double the capacity, which is designed to improve system reliability

GCX® variable height arm mount and keyboard tray provide users:

- Additional benchtop space underneath by elevating the AIO computer with the wireless keyboard with touchpad
- Easier access to ports and control buttons, helpful during service and maintenance
- Ability to move the arm mount up and down and tilt for optimal viewing and positioning

HD barcode scanner and holder offers:

- Automatic or manual scanning of the Sample Buffer Tubes
- Scanner holder to help keep your benchtop clean and orderly



Consolidate your molecular testing to the BD MAX™ PLUS platform

Get the best out of the broad and clinically relevant suite of BD MAX™ molecular assays and adapt quickly to your lab's evolving needs.*

Respiratory infections

Help address and contain the spread of respiratory infections with accurate and timely testing.

SARS-CoV-2

BD SARS-CoV-2 Reagents for BD MAX™ System (■ Cat: 445003-01)
SARS-CoV-2 (N1+N2)

VIASURE SARS-CoV-2 (N1+N2) Real Time PCR Detection Kit for BD MAX™ System (■ Cat: 444215)
SARS-CoV-2 (N1 + N2)

SARS-CoV-2 / Flu or RSV

BD SARS-CoV-2/Flu for BD MAX™ System (■ Cat: 445011)
SARS-CoV-2 (N1 + N2), Flu A, Flu B

BD Respiratory Viral Panel for BD MAX™ System (■ Cat: 445215)
SARS-CoV-2 (N1+N2), Flu A, Flu B, RSV

VIASURE SARS-CoV-2, Flu (A+B) & RSV Real Time PCR Detection Kit for BD MAX™ System (■ Cat: 444217)
SARS-CoV-2 (N1 + N2), Flu A, Flu B, RSV

Other respiratory assays

VIASURE Flu A, Flu B & RSV Real Time PCR Detection Kit for BD MAX™ System (■ Cat: 444200)
Flu A, Flu B, RSV

VIASURE *Pneumocystis jirovecii* Real Time PCR Detection Kit for BD MAX™ System (■ Cat: 444207)
Pneumocystis jirovecii

VIASURE *Bordetella* Real Time PCR Detection Kit for BD MAX™ System (■ Cat: 444204)**
Bordetella pertussis, *Bordetella parapertussis*, *Bordetella holmesii*

Enteric solutions

Simplify gastroenteritis testing with focused panels.

Enteric bacteria

BD MAX™ Enteric Bacterial Panel (■ Cat: 442963)
Salmonella spp., *Campylobacter spp.* (*C. jejuni* and *C. coli*), *Shigella spp.* (including Enteroinvasive *Escherichia coli* [EIEC]), *Shiga toxin 1 (stx1)* / *Shiga toxin 2 genes (stx2) genes*

BD MAX™ Extended Enteric Bacterial Panel (■ Cat: 443812)
Plesiomonas shigelloides, *Vibrio spp.* (*V. vulnificus*, *V. parahaemolyticus*, *V. cholerae*), Enterotoxigenic *E. coli* (ETEC), *Yersina enterocolitica*

Enteric viruses

BD MAX™ Enteric Viral Panel (■ Cat: 443985)
Norovirus GI & GII, Rotavirus A, Adenovirus F40/41, Sapovirus (genogroups I, II, IV, V), Human Astrovirus (hAstro)

BD MAX™ Enteric Viral Panel-NR (■ Cat: 443987)
Norovirus GI & GII, Rotavirus A

Enteric parasites

BD MAX™ Enteric Parasite Panel (■ Cat: 442960)
Giardia lamblia, *Cryptosporidium (C. hominis and C. parvum)*, *Entamoeba histolytica*



Reagents can be stored at room-temperature, making inventory and storage more convenient for you.

Healthcare-associated infections

Proper infection control and prevention requires active, timely surveillance and testing.

Clostridioides difficile

BD MAX™ Cdiff (■ Cat: 442555)

Clostridioides difficile toxin B gene (*tcdB*)

Staphylococcus aureus

BD MAX™ MRSA XT (■ Cat: 443461)

Methicillin-resistant *Staphylococcus aureus* (MRSA) (11 MREJ types including *mecA* and *mecC* resistance)

BD MAX™ StaphSR (■ Cat: 443419)

Staphylococcus aureus, Methicillin-resistant *Staphylococcus aureus*, (MRSA) (11 MREJ types including *mecA* and *mecC* resistance)

Carbapenemase-producing organisms (CPO)

BD MAX™ CPO (■ Cat: 445262)

KPC, NDM, OXA-48 (OXA-48 and OXA-48 like), VIM/IMP

Vancomycin resistance

VIASURE Vancomycin resistance Real Time PCR Detection Kit for BD MAX™ System (■ Cat: 444202)

vanA and *vanB* genes

Women's health & STIs

The right treatment starts with the right diagnosis.

Sexually transmitted infections (STIs)

BD CTGCTV2 for BD MAX™ System (■ Cat: 443906)

Chlamydia trachomatis, *Neisseria gonorrhoeae*, *Trichomonas vaginalis*

BD CTGC2 for BD MAX™ System (■ Cat: 443905)

Chlamydia trachomatis, *Neisseria gonorrhoeae*

Vaginitis

BD MAX™ Vaginal Panel (■ Cat: 443712)

Bacterial vaginosis markers*** (*Lactobacillus* spp. (*L. crispatus* and *L. jensenii*), *Gardnerella vaginalis*, *Atopobium vaginae*, Bacterial Vaginosis Associated Bacteria-2 (BVAB-2), *Megasphaera-1*)
Candida spp. (*C. albicans*, *C. tropicalis*, *C. parapsilosis*, *C. dubliniensis*), *Candida glabrata*, *Candida krusei*, *Trichomonas vaginalis*

Antepartum

BD MAX™ GBS (■ Cat: 441772)

Group B *Streptococcus*

BD MAX™ Open-System Reagents: embrace flexibility with open system and partner assays

The BD MAX™ Open-System Reagents allow you to create your own lab-developed tests or run third-party assays to address emerging diagnostic demands and meet local healthcare needs.

	DNA Extraction Kits: Allows for extraction of DNA		TNA Extraction Kits: Allows for extraction of DNA & RNA	
	BD MAX™ ExK™ DNA-1 442818	BD MAX™ ExK™ DNA-2 442820	BD MAX™ ExK™ TNA-2 442826	BD MAX™ ExK™ TNA-3 442828
Extraction	Plasma	●		
	Serum	●		
	Urine	●		
	Cerebral Spinal Fluid		●	●
	Dry Swab		●	
	Swab in UTM			

TNA Master Mix Kits:

A complete PCR reagent mix for amplification of DNA

Amplification	BD MAX™ DNA MMK (SPC) 442829	Contains primers and probes to detect BD sample processing control
	BD MAX™ DNA MMK 442848	Does not contain primers and probes to detect BD sample processing control

TNA Master Mix Kits: A complete PCR reagent mix for amplification of total nucleic acids (DNA & RNA)

BD MAX™ TNA MMK (SPC) 442830	Contains primers and probes to detect BD sample processing control
--	--

IVD assays, research use only (RUO) assays and user-defined protocols (UDP) cannot be combined in the same rack.

Seal In-house Reagents with the Axygen™ PlateMax™ Semi-Automated Plate Sealer

Accessories	BD MAX™ Conical Tube Holder 443412*	BD MAX™ 5-Color Seal Sheets 443413*	BD MAX™ Barcoded Seal Sheets, 3 Codes 444159*	BD MAX™ Barcoded Seal Sheets, 5 Codes 444160*	BD MAX™ Bulk Conical Tubes 437016	BD MAX™ Bulk Conical Tubes 443999
						
	Holds 54 tubes	50 sheets per pack (2700 tests)	48 sheets per pack (2592 tests)	50 sheets per pack (2700 tests)	100 tubes per box	5000 tubes per box

*443412, 443413, 444159, and 444160 are designed to fit with the Axygen™ PlateMax™ Semi-Automated Plate Sealer (VWR 89203-178, Fisher 14-223-203)

Enhancing diagnostics with informatics solutions

BD Synapsys™ Informatics Solution enables secure connectivity and on-demand analytics for users of the BD MAX™ PLUS System.

This initial release sets the groundwork for future features and capabilities for the BD MAX™ PLUS System, with more updates every six months.*



Bi-directional Laboratory Information System (LIS) integration



Single LIS interface for multiple BD MAX™ instruments utilised within standalone laboratories and multi-laboratory networks



Review results in BD Synapsys™ Informatics Solution for an expanding list of BD MAX™ System IVD molecular assays



Secure, browser-based technology enables anytime, anywhere access for multiple users and instruments



Robust cybersecurity with data security and privacy controls: UL CAP and SOC2 compliant

*New software updates are released approximately every 6 months. BD Synapsys™ Informatics Solution is compatible with BD MAX™ PLUS System and previous models of the BD MAX™ System, depending upon instrument software version.

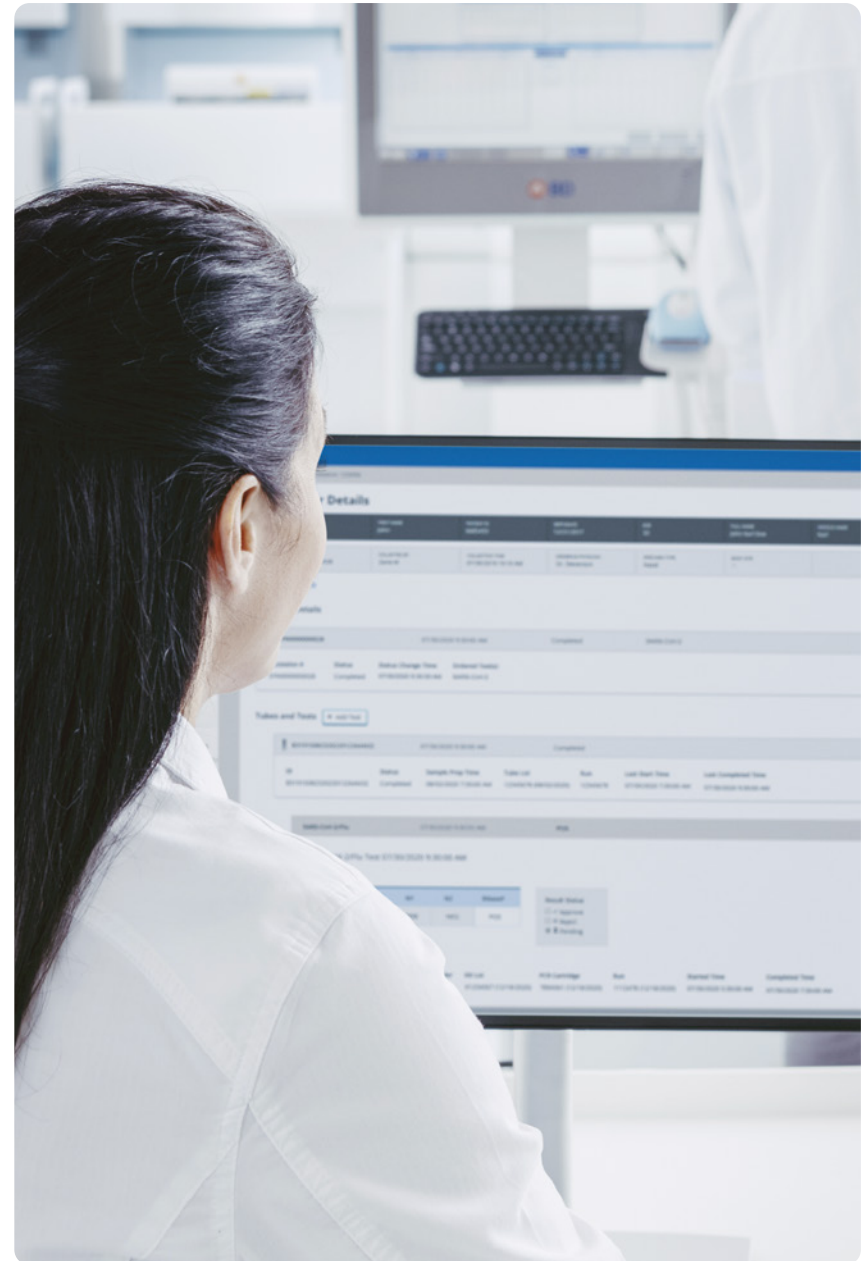

BD Synapsys™ Informatics Solution

is designed to provide near real-time analytics for quality control, administrative needs, infection prevention and physician requests.*



Molecular Details Page: anytime, anywhere results access via a web browser

- Access specimen test results and patient demographics anytime, anywhere
- Get a consolidated view of a specimen run on both BD MAX™ System and BD COR™ System

Order Utilisation Analytic: assay type and usage volume tracking

- Track assay usage at quarterly, monthly, and weekly level
- Assess usage of assays to aid in resource planning

Turnaround Time Analytic: near real-time monitoring of turnaround time (TAT)

- Review average TAT from specimen collection to result reporting
- Track TAT over time to help drive workflow changes to impact lab performance
- May help increase efficiency and improve quality of service

Statistic Banner Analytic: at-a-glance dashboard

- Customise dashboard with key testing metrics
- Monitor prevalence trends and other key testing metrics in near real-time

Drill Down Analytic: in-depth analysis of positive results

- Understand the distribution of infection within the population
- Analyse positive specimens broken down by patient or specimen demographics, allowing further data analysis

More performance, efficiency and versatility at your fingertips

Upgrade your molecular capabilities today and achieve even more with the BD MAX™ PLUS System.



Choose the full BD MAX™ PLUS System

Cat.	Description
441916	BD MAX™ PLUS Molecular Diagnostic System
445284	BD MAX™ PLUS Starter Kit includes Touch Pad Keyboard, AIO computer, USB cable, USB key, and HD Barcode Scanner and Stand
445268	BD MAX™ Monitor Arm Installation Kit includes GCX® Arm Mount, GCX® Keyboard Tray, and Monitor Arm Installation Bracket
257819	Printer
444934	BD Synapsys™ Lab Conn - MAX Term (Connectivity & Workflow Management license)
444937	BD Synapsys™ Advanced – Molecular (Advanced Analytics license)

BD Synapsys™ Informatics Solution is compatible with BD MAX™ PLUS System and previous models of the BD MAX™ System, depending upon instrument software version.



Upgrade your current BD MAX™ System with our latest innovations



Cat: 445268

BD MAX™ Monitor Arm Installation Kit*

Includes GCX® Arm Mount, GCX® Keyboard Tray, and Arm Mount Bracket Assembly

Requires new AIO & Touch Pad Keyboard (sold separately)



Cat: 445277

Wireless Touchpad Keyboard Accessory*



Cat: 445275

HD Barcode Scanner Stand Kit*

Includes HD Barcode Scanner and Stand



Cat: 445219

BD MAX™ Fixed Magnet Assembly



Cat: 443686

BD MAX™ All-in-One (AIO) Computer*

Optional accessories:



Cat: 435120

Standard Optical USB Mouse



Cat: 444808

BD MAX™ Rack (4 EA)

Cat: 444807

BD MAX™ Rack (1 EA)

* All these components to be purchased as BD MAX™ PLUS Accessories Upgrade Kit.

BD MAX™ PLUS System continues to support your laboratory with a simplified, efficient and streamlined workflow

BD MAX™ PLUS System offers you a fully integrated, automated real-time PCR platform with a broad menu of molecular IVD and open-system tests.⁵

Snap



Assemble unitised reagent strips with ready-to-use reagents

Load



Load Sample Buffer Tubes, Racks, and PCR cartridges.

Go



Come back in an average of 2.5 hours for results.*^{1,4}

*Assay times may vary.

- Less than 1.5 minutes hands-on time per sample^{1,3}
- 24 patient results in 2 to 3 hours, on average^{1,4}
- 96 samples per 8 hour shift¹

AIO, all-in-one; FDA, Food and Drug Administration; IVD, in vitro diagnostic; MMK, Master Mix Kit; PCR, polymerase chain reaction; RUO, research use only; UDP, user-defined protocols.

1. Felder RA et al. J Lab Autom. 2014;19(5):468–73.

2. BD MAX™ Vaginal Panel. [Instructions for Use]. Becton, Dickinson and Company: Franklin Lakes, NJ; 2022. P0258.

3. Hirvonen JJ et al. Eur J Clin Microbiol Infect Dis. 2015;34(5):1005–9.

4. BD MAX™ Enteric Bacterial Panel [Instructions for Use]. Becton, Dickinson and Company.

5. BD MAX™ System User's Manual. Becton, Dickinson and Company: Sparks, MD.

BD Switzerland Sàrl, Route de Crassier 17, Business Park Terre-Bonne, Batiment A4, 1262 Eysins, Switzerland

CE The BD MAX™ System, BD MAX™ Enteric Bacterial & Extended Enteric Bacterial Panels, BD MAX™ Enteric Viral Panel, BD MAX™ Enteric Viral Panel-NR, BD MAX™ Enteric Parasite Panel, BD MAX™ Vaginal Panel, BD MAX™ CPO, BD MAX™ MRSA XT, BD MAX™ StaphSR, BD MAX™ Cdiff, BD MAX™ MDR-TB, BD SARS-CoV-2 Reagents for BD MAX™ System, BD SARS-CoV-2/Flu for BD MAX™ System, BD Respiratory Viral Panel for BD MAX™ System, VIASURE SARS-CoV-2 (N1+N2) Real Time PCR Detection Kit for BD MAX™ System, VIASURE SARS-CoV-2, Flu (A+B), RSV Real Time PCR Detection Kit for BD MAX™ System, VIASURE Flu A, Flu B & RSV Real Time PCR Detection Kit for BD MAX™ System, VIASURE Vancomycin Resistance Real Time PCR Detection Kit for BD MAX™ System, VIASURE *Pneumocystis jirovecii* Real Time PCR Detection Kit for BD MAX™ System, VIASURE Bordetella Real Time PCR Detection Kit for BD MAX™ System are in vitro diagnostic medical devices bearing a CE mark.

CE 2797 The BD CTGCTV2 and BD CTGC2 for BD MAX™ System are in vitro diagnostic medical devices bearing a CE mark and are CE certified by BSI Group The Netherlands B.V. (Notified Body Number = 2797).

bd.com

BD, the BD Logo, BD Logo, BD MAX, and BD Synapsys are trademarks of Becton, Dickinson and Company or its affiliates. All other trademarks are the property of their respective owners. © 2022 BD. All rights reserved. BD-68935

